

w2 180.0 Plury

Tons 20.0 - 40.0

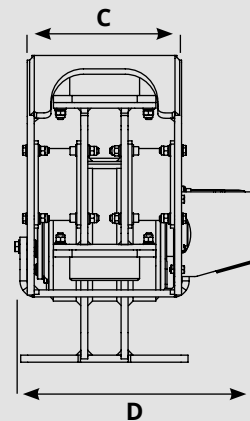

Model	PLURY W2 180.0
A (mm)	1220
B (mm)	920
C (mm)	440
D (mm)	710
Peso / Weight (Kg)	837
Motore / Engine (CC)	63
Portata Olio Hydraulic Fluid Flow Rate (L/Min)	135
Pressione / Pressure (BAR)	150/220
Frequenza Vibrazione Vibration Rate (RPM)	2.143
Forza centrifuga Centrifugal Force (Kn)	180
Hertz	36

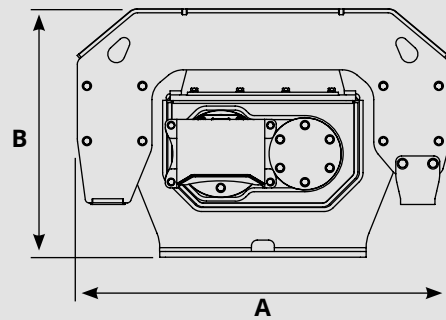

MACHINE ATTACHMENTS

Tons 8.0 - 40.0



ATTACCHI MACCHINE / MACHINE ATTACHMENTS

ADATTATORE PER ATTACCO RAPIDO
ADAPTER FOR QUICK COUPLING



ATTACCO MACCHINA FISSO
FIXED COUPLING TO THE MACHINE

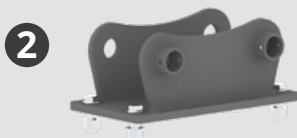

PIASTRA ATTACCO MACCHINA
BOLTED PLATE TO THE MACHINE COUPLING

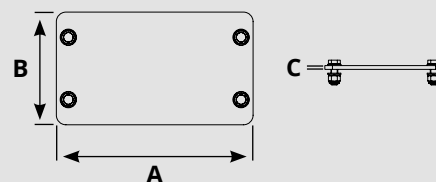
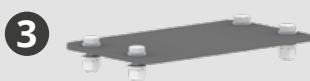

TOK ATTACCO RAPIDO 8/40 TON
TOK QUICK COUPLER 8/40 TON

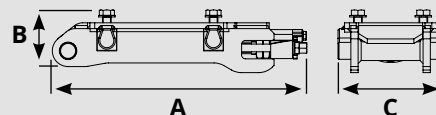
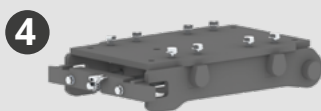

TOK ADATTATORE 8/40 TON
TOK ADAPTER 8/40 TON

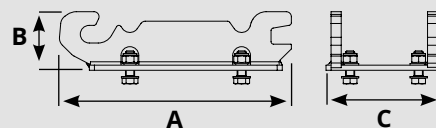

	Model	A mm	B mm	C mm	Kg.	€
1	ADAPTER FOR QUICK COUPLING	/	/	/	/	
2	FIXED COUP. TO THE MACHINE	/	/	/	/	
3	BOLTED PLATE TO MACHINE COUPLING	920	450	20	70	
4	TOK QUICK COUPLER 8/40 ton	805	160	480	140	
5	TOK ADAPTER 8/40 ton	750	175	475	88	