

w1 27.0 Plury

Tons 4.0 - 10.0

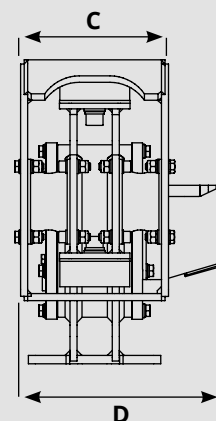

Model	PLURY W1 27.0	PLURY W1 27.0	PLURY W1 27.0
A (mm)	680	680	680
B (mm)	540	540	540
C (mm)	272	272	272
D (mm)	395	395	395
Peso / Weight (Kg)	187	187	187
Motore / Engine (CC)	21	27	32
Portata Olio Hydraulic Fluid Flow Rate (L/Min)	45	57	69
Pressione / Pressure (BAR)	150/220	150/220	150/220
Frequenza Vibrazione Vibration Rate (RPM)	2.133	2.111	2.143
Forza centrifuga Centrifugal Force (Kn)	27	27	27
Hertz	36	36	36

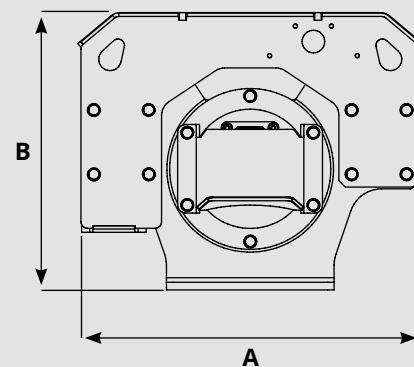

MACHINE ATTACHMENTS

Tons 4.0 - 12.0



ATTACCHI MACCHINE / MACHINE ATTACHMENTS

ADATTATORE PER ATTACCO RAPIDO
ADAPTER FOR QUICK COUPLING



ATTACCO MACCHINA FISSO
FIXED COUPLING TO THE MACHINE

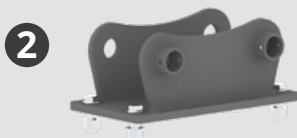

PIASTRA ATTACCO MACCHINA
BOLTED PLATE TO THE MACHINE COUPLING

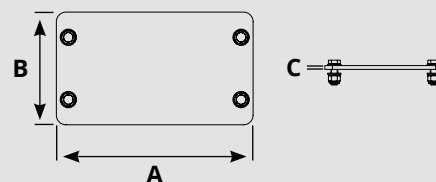
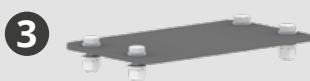

TOK ATTACCO RAPIDO 4/12 TON
TOK QUICK COUPLER 4/12 TON

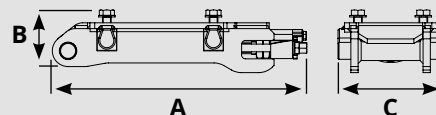

TOK ADATTATORE 4/12 TON
TOK ADAPTER 4/12 TON

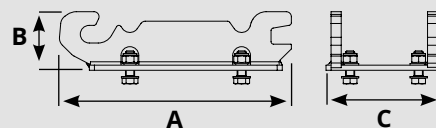

	Model	A mm	B mm	C mm	Kg.	€
1	ADAPTER FOR QUICK COUPLING	/	/	/	/	
2	FIXED COUP. TO THE MACHINE	/	/	/	/	
3	BOLTED PLATE TO MACHINE COUPLING	470	280	15	16.5	
4	TOK QUICK COUPLER 4/12 ton	625	120	295	53	
5	TOK ADAPTER 4/12 ton	570	160	290	37	