

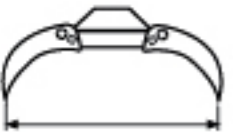





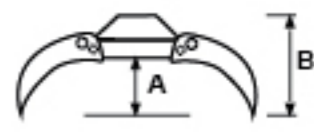





 **1,5 - 1,7 ton**

		 MAX									
mm	Kg.	bar	lt.	m <sup>2</sup>	mm	mm	mm	mm	A mm	B mm	mm
1090	48	100	20	0,12	640	70	600	400	330	540	310