



ROBUSTRACK
EXCAVATORS & ATTACHMENTS

LSI REVERSIBLE FLAIL MOWER









Y Blade \varnothing 2 cm

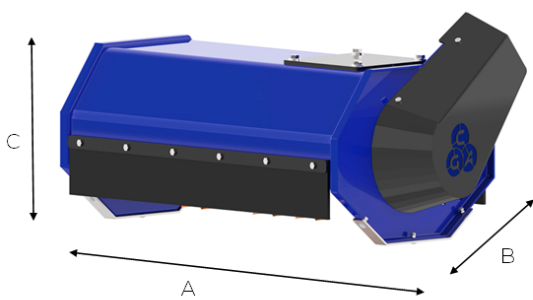

Hammer \varnothing 3 cm

Compact and strong yet light, the LSI range of flail mowers are the perfect solution for hedge cutting and ground clearing with small machines, suitable for grass, brambles and hedges up to 2-3 cm in diameter. Supplied with a protective rubber guard, anti-cavitation/flow control: a system that stops any spike in pressure/sudden stoppage from damaging



	TONS	1.2-2.5	1.2-2.5	
MOD.		LS1600	LS1800	
ALT.		TTE 60SL	TTE 80SL	
A.	MM	850	1000	
B.	MM	500	500	
C.	MM	350	350	
	WEIGHT	KG	70	80
	OIL REQ.	LTR/MIN	20-30	30-40
	PRESSURE	BAR	170-220	170-220
	TRANSMISSION		DIRECT	DIRECT
	CUT WIDTH	MM	600	800